

Toilet Cubicle Fittings and Accessories For 12-13 mm Board

• Application

- General purpose cubicles of compact grade laminate, plywood, etc. construction where board thickness is normally 12-13 mm incorporating decorative laminate facing
- Ideal for site situations

Part detail of range of cubicles showing general position of components

- A** - Headrail
- B** - Channel brackets (set of 3)
- C** - Hinges (pair)
- D** - Cubicle support
- E** - Toilet roll holder (not shown)
- F** - Indicator bolt
- K** - Open out keep (not shown, see page 23)
- L** - D handle (not shown, see page 23)

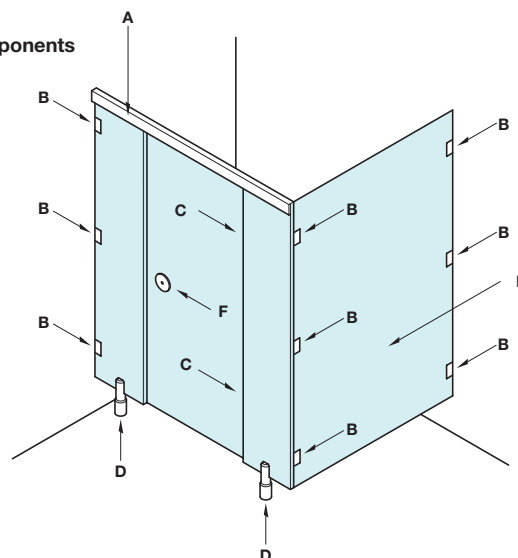

5

A Headrail

- To suit board thickness 12-13 mm
- Screw fixed to top of pilasters - client to drill
- Supplied in two lengths - dependant on finish
- Aluminium

Finish	Length	Cat. No.
Satin anodised	4 m	980.07.901
Black polyester powder coated	3 m	980.07.301

Order qty: 1 length

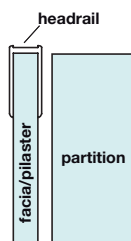
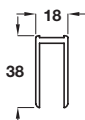

Satin anodised finish

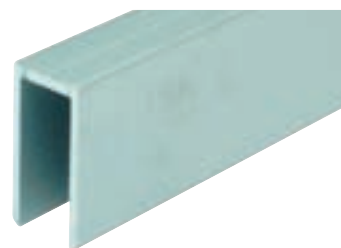

B Channel bracket sets

- To suit board thickness 12-13 mm
- Available in 2 types
- Supplied in sets of 3, complete with bush bolts and fixings
- To fix division panels to rear walls and front pilasters and fix end pilaster to wall
- Suitable for matching modesty panel fixings
- Aluminium

Wall fixing	Cat. No.
Satin anodised	980.07.913
Black polyester powder coated	980.07.313
Through fixing	Cat. No.
Satin anodised	980.07.914
Black polyester powder coated	980.07.314

Order qty: 1 set

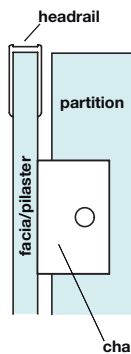
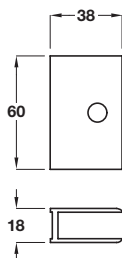

Satin anodised finish



C Hinge set, normal duty

- Supplied in pairs with strong through fixings to suit board thickness 12-13 mm
- Reversible. Rise or fall - turn cam to suit
- Aluminium

Finish	Cat. No.
Satin anodised	980.07.922
Black polyester powder coated	980.07.322

Order qty: 1 pair

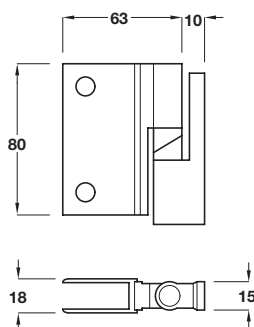

Satin anodised finish

