

Fittings for Straight Sliding Timber/Metal Interior Doors

Straightaway 100

- **Normally for interior straight sliding timber or metal doors weighing up to 100 kg**
- **Application:** Top hung either side or soffit fixed, straight sliding doors for domestic, school, hospital use, etc.
- **Range:** Maximum door weight **100 kg**
Maximum door height **2.5 m**
Door thickness **20-50 mm**
- **Door construction** - Adequate top rail required to provide secure fixing of hanger. Minimum door thickness 30 mm when using floor guide channel.

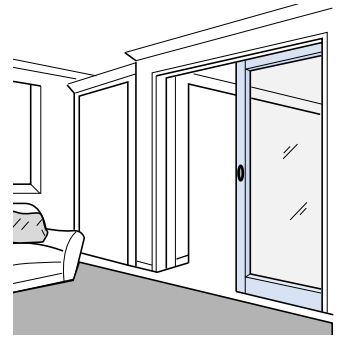
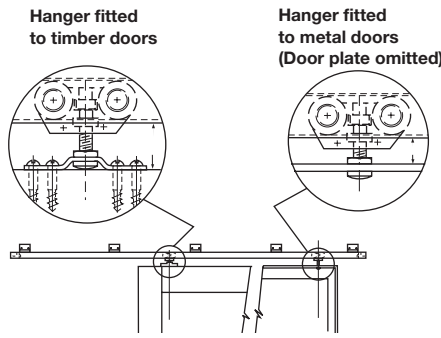

For ancillary door fittings, locks, handles, bolts, seals, etc. see pages 4-6

A Top track, 30 x 30 mm

Soffit fixing or side fixing with bracket **D**. Galvanized steel

Length	2.1 m	3.0 m
Cat. No.	941.06.921	941.06.930

Order qty: 1 pc (2.1 or 3.0 m length)

B Radius track curve

600 mm radius. Galvanized steel

Cat. No.	941.06.906
----------	------------

Order qty: 1 pc (0.6 m length)

C Top track, 30 x 30 mm

Pre-drilled for soffit fixing or side fixing with bracket **D**. Stainless steel

Length	3.0 m
Cat. No.	941.06.931

Order qty: 1 pc (3.0 m length)

D Side fixing bracket

Extruded aluminium. For use with galvanized steel and stainless steel tracks only - top tracks **A** and **C**

Cat. No.	941.06.080
----------	------------

Order qty: 1 pc (1 pc required every 500 mm)

E Closed end piece

To convert **D** to closed end bracket and prevent lateral movement of track. Galvanized steel

Cat. No.	941.06.081
----------	------------

Order qty: 1 pair (1 pair required per length of track)

F Top track, 30 x 30 mm

Alternative to track **A** and **C**. Drilled for soffit fixing only. Bright extruded aluminium

Length	2.1 m	3.0 m
Cat. No.	941.06.821	941.06.830

Order qty: 1 pc (2.1 or 3.0 m length)

G Trolley hanger

Door plate omitted when hanger is fitted to metal doors. Galvanized steel with four nylon wheels

Cat. No.	941.06.012
----------	------------

Order qty: 1 pair (1 pair required per panel)

H Height adjustment spanner

Required to adjust the position of the trolley hangers for final door alignment. Galvanized steel

Cat. No.	941.06.090
----------	------------

Order qty: 1 pc (1 pc required per application)

I Track stopper

Medium duty. For use with track **A**, **C** and **F**. Galvanized steel with nylon clamp.

Important: Spacer nib must be filed off when used with aluminium track **F**

Cat. No.	941.06.040
----------	------------

Order qty: 1 pair (1 pair required per panel)

J Rubber buffer, screw fixing. Black rubber

Cat. No.	407.01.930
----------	------------

Order qty: 1 pc

K Bottom channel insert 25 x 25 mm

Pre-drilled for countersunk screws. Bright aluminium

Length	2.1 m	3.0 m
Cat. No.	942.51.721	942.51.730

Order qty: 1 pc (2.1 or 3.0 m length)

L Clear threshold bottom guide, opaque fibre/polypropylene

Cat. No.	407.51.059
----------	------------

Order qty: 1 pc (1 pc required per panel)

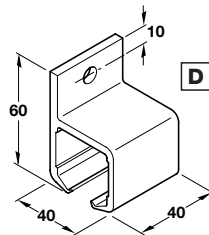
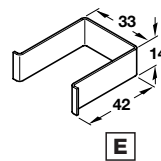
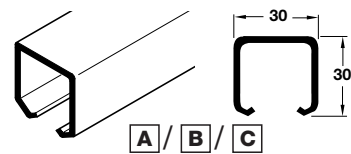
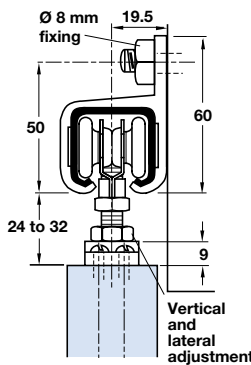

Not for use with side fixing bracket **D**

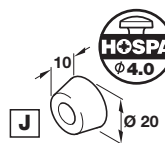
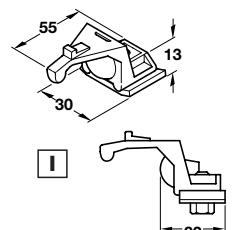
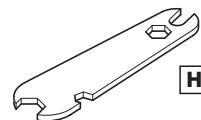
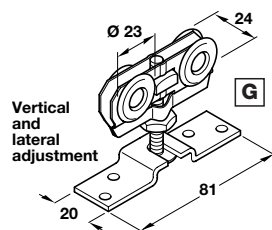
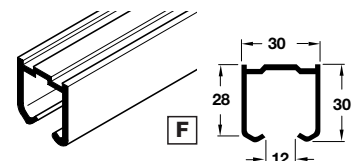

Medium duty clear threshold

Maximum door width normally 1.5 m

