

- Application:** Inset single and double parallel sliding glass panels with frame profile - for high quality work
- Range:** Max. door weight **35 kg**
Glass door thickness **6 - 8 mm**
- Clipo 35 GK** - aluminium glass fixing frame at top only and surface fixed guide at base
- Clipo 35 GKK** - frame at top and bottom of panel
- For ancillary door hardware i.e. locks and door pulls etc. refer to pages 83-85**

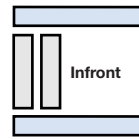

Top track groove mounted
No groove in floor
Without fascia
With concealed running gear

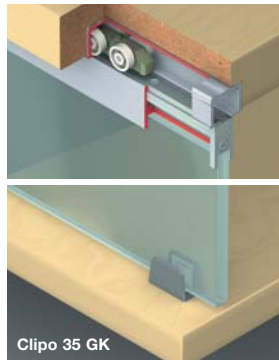

A Single top track

With screw holes for soffit fixing into a groove. For min. 30 mm thick upper carcass. Bright aluminium

Length	2.5 m	3.5 m
Cat. No.	405.00.250	405.00.350

Order qty: 1 pc (2.5 or 3.5 m length)

B Single top track end piece

Cap to support ends of track. Grey plastic

Cat. No.	405.00.070
----------	------------

Order qty: 1 pc (order 2 pcs per length of track)

C Double top track

With screw holes for soffit fixing into a groove. For min. 30 mm thick upper carcass. Bright aluminium

Length	2.5 m	3.5 m
Cat. No.	405.02.250	405.02.350

Order qty: 1 pc (2.5 or 3.5 m length)

D Double top track end piece

Cap to support ends of track. Grey plastic

Cat. No.	405.00.071
----------	------------

Order qty: 1 pc (order 2 pcs per length of track)

E Aluminium frame profile

Silver anodised aluminium

Length	2.5 m	3.5 m
Cat. No.	405.03.250	405.03.350

Order qty: 1 pc (2.5 or 3.5 m length)

Clipo 35 GK and 35 GKK fitting sets

F Spacer, for use with 6 mm glass in frame profile - positions glass centrally, making glueing easier

G Cover cap for bottom frame profile, required for Clipo 35GKK only. Zinc alloy.

H Stopper. For top track. With retaining spring. Grey plastic

I Running gear for GK and GKK. Vertical adjustment ± 2 mm. Bright zinc alloy

J Mounting screw, M5 x 20. For fixing running gear to suspension block. Galvanized steel

K Suspension block. For insertion and screw fixing in glass frame profile. Bright zinc alloy

L Bottom guide for GK. Screw fixing to base. For glass thickness of **6-8 mm**. Matt chrome-plated aluminium

M Bottom guide for GKK. Rattle-proof. Screw fixing to base. For use with bottom glass frame profile. Grey plastic

Fitting sets for 1 door	35 GK	35 GKK
F Spacer for 6 mm glass	2 pcs	4 pcs
G GKK profile cover cap	-	2 pcs
H Stopper	2 pcs	2 pcs
I Running gear	2 pcs	2 pcs
J Mounting screw	2 pcs	2 pcs
K Suspension block	2 pcs	2 pcs
L GK Bottom guide	1 pc	-
M GKK Bottom guide	-	1 pc
Cat. No.	405.02.008	405.02.009

Order qty: 1 set (order 1 set per door)

Additional set parts	Cat. No.
G Cover cap for profile	405.02.023
L Bottom guide	405.83.160

Order qty: 1 pc

N Push button cylinder locks

For installation on the end of glass door profile.

For glass panels **6 - 8 mm** thick.

Matt chrome-plated zinc alloy. **Accessories:** 2 keys

	Left hand	Right hand
Cat. No.	405.02.091	405.02.090

Order qty: 1 pc (order 1 pc per pair of doors)

Tracks, profiles and glue are not included in the fittings sets and must be ordered separately

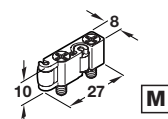
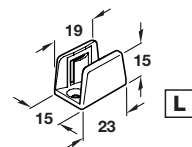
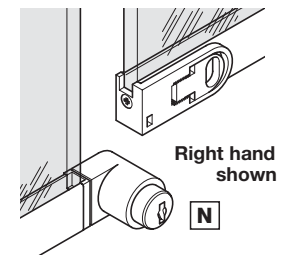
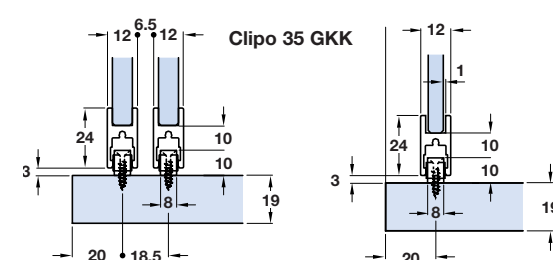
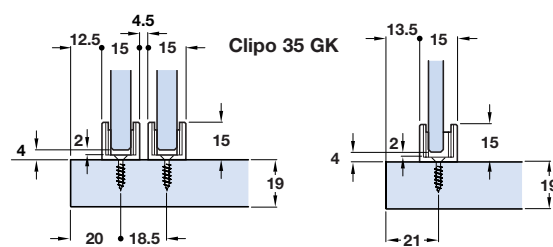
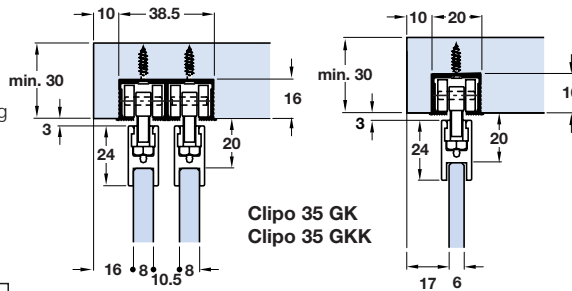
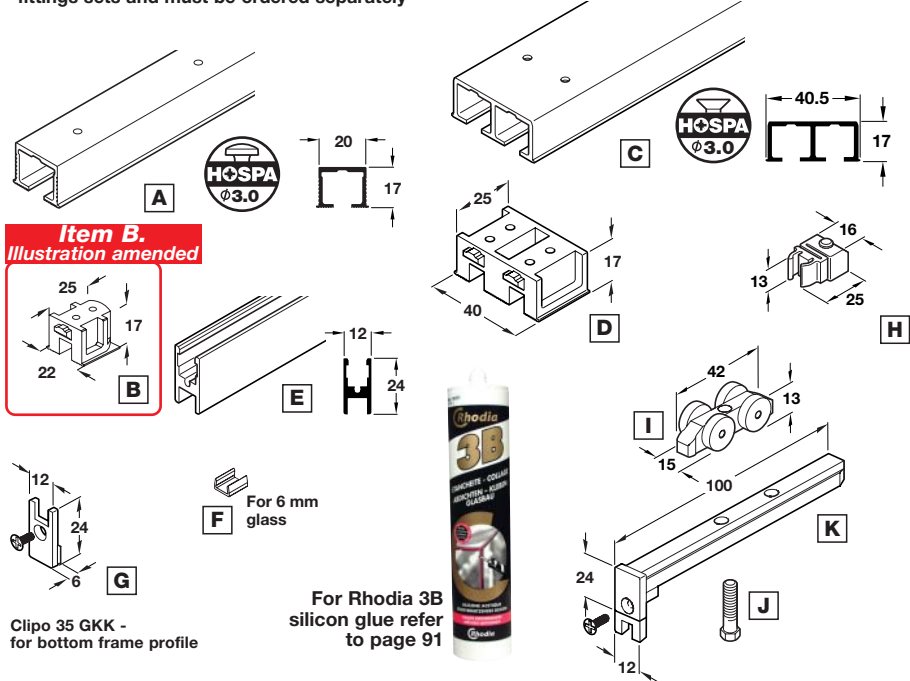

03.02.09/1*