

- Application:** Top hung system for wardrobes, cupboards and similar doors. Single or multiple runs of track. Heavy-duty use
- Range:** Max. door weight **45 kg**
Max. door height **2.1 m**
Max. door width **1.2 m**
- Recommended door construction**
Door thickness: **20-40 mm**
Door frame width: **Min. 38 mm** to accommodate hanger aprons
Door width: Quarter height minimum
- Fixing:** Top track soffit fixed. Individual tracks allow for variation of door thickness. Guides at floor level recessed or surface fixed. On triple track installations floor channel **G** together with bottom guides **F** should be used as shown below. Position hangers close to edge of doors
Sets are supplied with fixing materials
- Complete fitting sets** are available for two or three doors. **Single door fitting set** also available for when another door is added.
- Hanger B** can be supplied separately if required

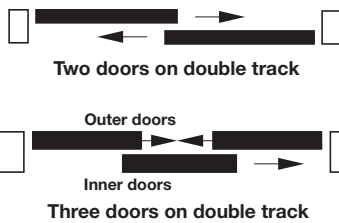

Door thickness	Dim x
20 mm	2 mm
22 mm	4 mm
25 mm	7 mm
30 mm	12 mm
32 mm	14 mm
35 mm	17 mm
40 mm	22 mm



Twin 100 complete fitting sets

- A Top track.** Drilled for soffit fixing. 1.8 and 2.4 m lengths when supplied in packed sets. 2.4 m length only when supplied separately. Aluminium
- B Rear hanger.** Back fixing. Nylon wheels, ground steel axles, plated steel adjustable aprons
- C Front hanger.** Back fixing. Nylon wheels, ground steel axles, plated steel adjustable aprons
- D Door stop.** Nylon with rubber buffer
- E Bottom guide.** Wood screw fixing. Nylon - used in pairs

Twin 100 complete sets

Fitting sets for	2 doors	3 doors
A Top track	2 lengths	2 lengths
B Rear hanger	2 pcs	2 pcs
C Front hanger	2 pcs	4 pcs
D Door stop	1 pc	2 pcs
E Bottom guide	4 pcs	6 pcs

Set	Door opening	Track length	Cat. No.
6 H	1.8 m	1.8 m	407.19.239
8 H	2.4 m	2.4 m	407.19.328

Single door fitting set

For additional door	
C Front hanger	2 pcs
D Door stop	1 pc
E Bottom guide	2 pcs

Set	Cat. No.
1 H	407.19.006

Order qty: 1 set

A Additional top track, 2.4 m length

Cat. No.	407.20.024
----------	------------

Order qty: 1 pc (2.4 m length)

B Additional rear hanger

Cat. No.	407.19.908
----------	------------

Order qty: 1 pair (order 1 pair per door)

F Bottom guide

Steel plate with nylon blade

Cat. No.	409.12.990
----------	------------

Order qty: 1 pc (order 2 pcs per door)

G Guide channel

Pre-drilled for countersunk screws. Bright aluminium

Length	2.1 m	3.0 m
Cat. No.	409.14.010	409.14.029

Order qty: 1 pc (2.1 or 3.0 m length)

H Bottom guide, heavier duty

For where a more robust guide is preferred, clear threshold. Black plastic

Cat. No.	940.40.031
----------	------------

Order qty: 1 pc (order 1 pc per door)

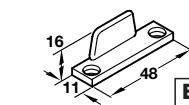
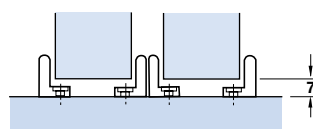
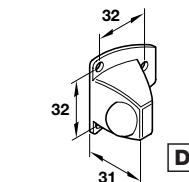
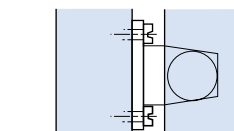
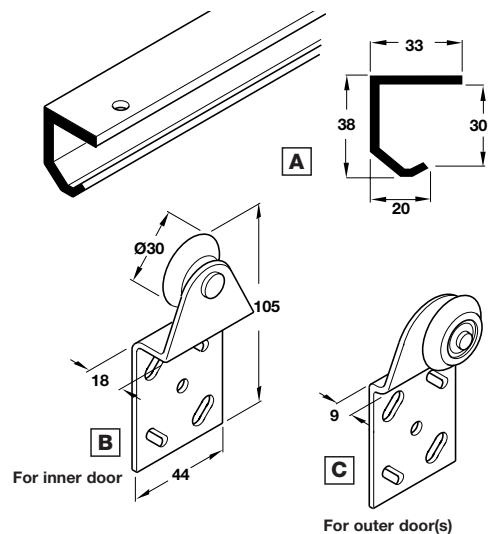
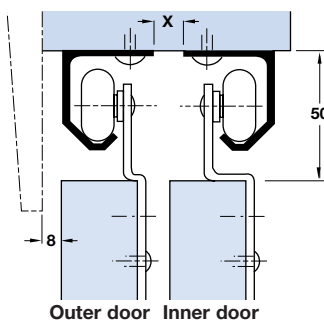

Optional guiding systems for extra robustness or triple track installations:
These must be ordered in addition to the complete set

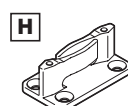
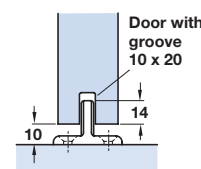
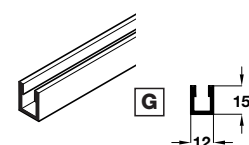
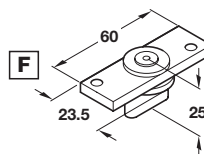
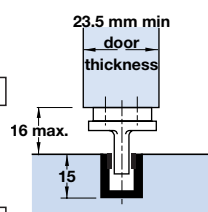

For ancillary door hardware i.e. locks, handles and bolts etc. refer to page 19