

- **Application:** High quality residential furniture where either **decorative** or **functional overlay** sliding panels are required to move across the face of units
- **Features:**
All sliding door gear components **concealed** including tracks
- **Simple to install**
Height adjustment ± 2 mm on running gear
- **Range:**
Max. door panel weight **25 kg**
For door thickness **19 - 25 mm**
Max. door height normally **2400 mm**
Max. door width normally **1000 mm**
- **Top track and bottom guide rail must be ordered separately**

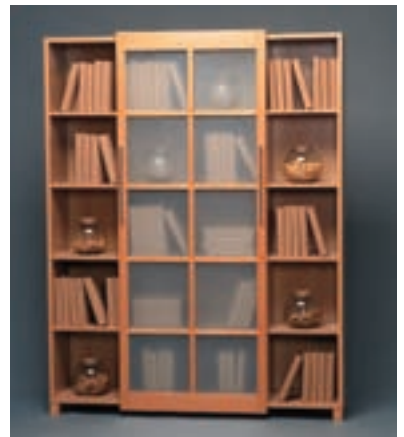
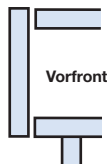

Top track screw fixing, concealed
Bottom track groove mounted under cabinet
With screw fixing running gear

For ancillary door hardware i.e. locks, handles and bolts etc. refer to page 19

A Concealed type top track

With screw-mounting holes. Bright aluminum

Length	2.5 m	3.5 m
Cat. No.	405.56.025	405.56.035

Order qty: 1 pc (2.5 or 3.5 m length)

Regal-A 25 fitting set

- B Track stopper, left hand.** With retaining spring. For top track. Grey plastic
- C Track stopper, right hand.** With retaining spring. For top track. Grey plastic
- D Running gear.** For door panels up to **25 kg**. Plastic-tyred wheel with ball bearing. Yellow chromatised steel
- E Bottom guide.** With slotted fixing holes for easy installation. Yellow chromatised steel
- F Guide buffer.** To fit in bottom guide rail. Grey plastic

Fixings and installation instructions included

Fitting set	for single wooden panel
B Track stopper, left	1 pc
C Track stopper, right	1 pc
D Running gear	2 pcs
E Bottom guide	2 pcs
F Guide buffer	2 pcs
Cat. No.	405.55.011

Order qty: 1 set (order 1 set per door)

G Bottom guide rail

With screw-mounting holes. Bright aluminum

Note: If cabinet board thickness is 19 mm, glue into position

Length	2.5 m	3.5 m
Cat. No.	405.30.025	405.30.035

Order qty: 1 pc (2.5 or 3.5 m length)

H Centre door stopper, optional use

Allows panel to be held in a central position as well as at either side if the track running length is sufficient. Grey plastic

Cat. No.	405.33.030
----------	------------

Order qty: 1 pc (order 1 pc per door)

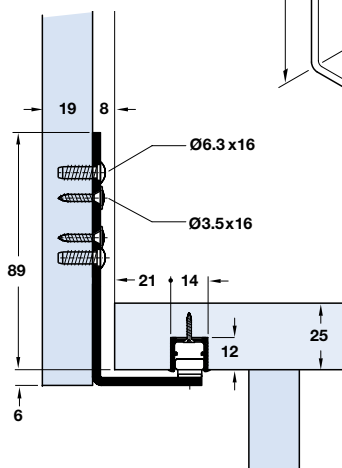
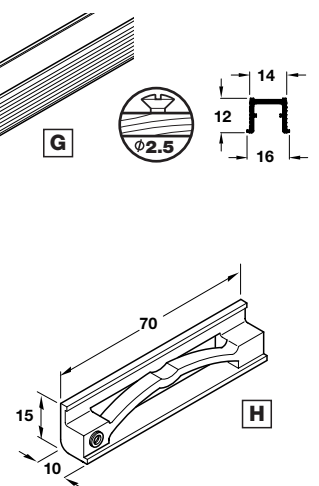
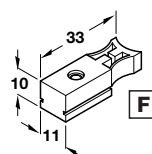
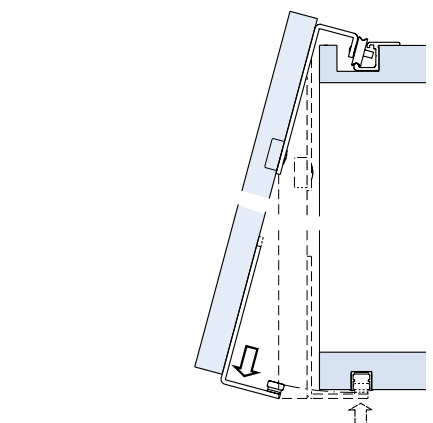
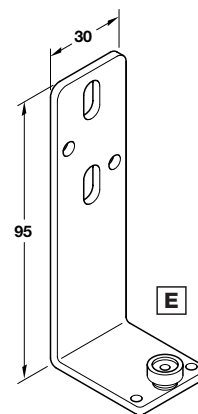
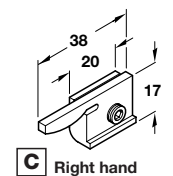
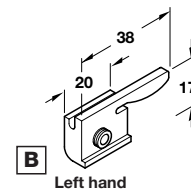
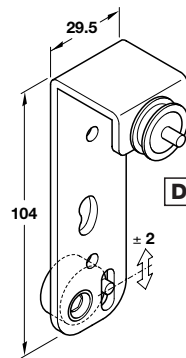
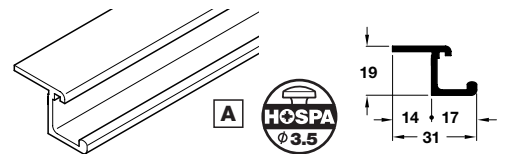
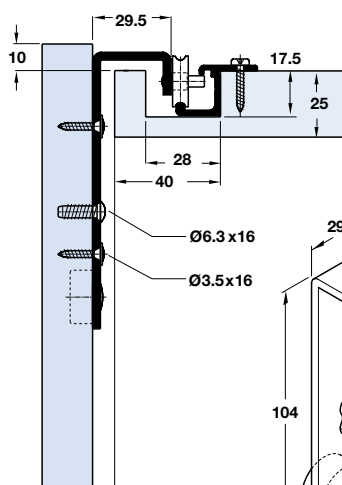

Concealed sliding door gear components
Panels move across face of units

TCH-A1 2008, HUK. Dimensional data not binding. We reserve the right to alter specifications without notice.