



HAWA-Aperto 40/F system can accommodate parallel stacking areas only.

For perpendicular stacking areas refer to HAWA-Aperto 60/H system shown in Section 11 pages 206-207

For ancillary door hardware i.e. locks, handles and bolts etc. refer to page 19



HAWA-Aperto 40/F parallel stacking area

75° Storage area track and channel set

For the parking area of sliding doors

Remaining straight run track and lower guide profile supplied in standard module sets comprising items **A, B and C** shown left

Silver anodised aluminium tracks and plates, black plastic channel and stops

| | |
|--|------------|
| J Curved single int. running track | 1 pc |
| K Curved single, ext. running track | 1 pc |
| L Curved bottom channel | 1 pc |
| M Double fixing plate | 1 pc |
| N Single fixing plate | 8 pcs |
| O Connecting pins | 6 pcs |
| P Set of stops, for bottom channel | 1 set |
| Q Set of stops, for top tracks | 1 set |
| R Centre stop | 1 set |
| S Socket wrench | 1 pc |
| Cat. No. | 400.70.900 |

Order qty: 1 set (order 1 set per storage area)

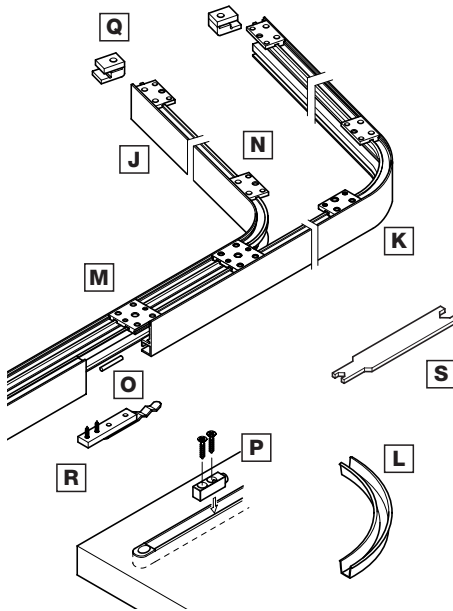

Line of tracks to accommodate doors in storage area

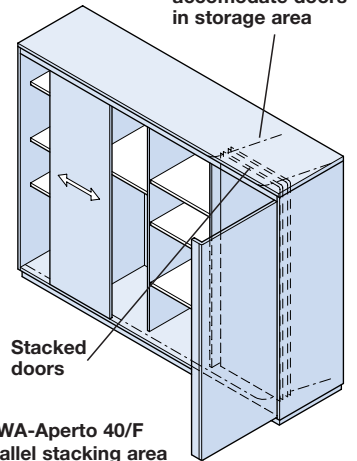

HAWA-Aperto 40/F parallel stacking area

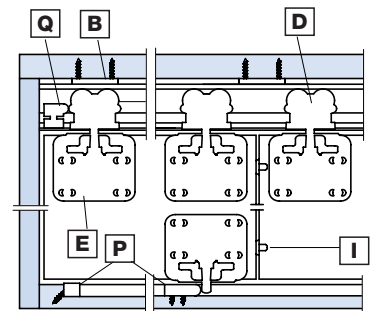

T Concealed hinge and mounting plate

To hang access door to storage area. Use adequate number of hinges to support heavier doors

Hinge: Ø 40 mm cup, slide on arm

| | |
|-------------------------------------|------------|
| Nickel-plated finish | Cat. No. |
| Hinge , 15 mm crank | 323.13.625 |
| Mounting plate , 4 mm height | 323.80.742 |

Order qty: 1 pc (order 3-5 pcs per door depending on door height)

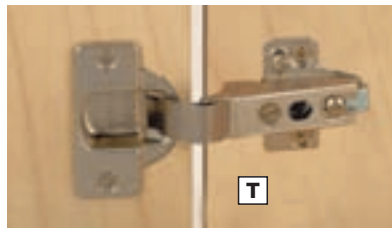

Detail of door closing off storage area

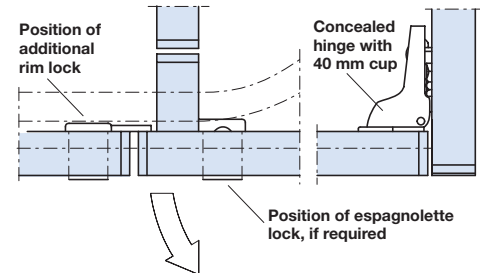

U Minilock 40 rim locks

With Ø 18 mm cylinder. Screw fixing. Left handed or right handed. Aluminium bolt and steel backplate. Matt nickel-plated zinc alloy case and cylinder.

5 plate levers = 200 possible key changes

Accessories: 2 keys. **Cylinder rosette must be ordered separately**

Spacer plates are available separately if required

| | | |
|---------------------------|------------|------------|
| Random key changes | Left | Right |
| Cat. No. | 230.12.704 | 230.12.606 |

Order qty: 1 pc

V Cylinder rosette

For use with Ø 18 mm cylinders
Matt nickel-plated brass

| | |
|----------|------------|
| Cat. No. | 219.19.676 |
|----------|------------|

Order qty: Multiples of 100 pcs

W Striking plate

For inset doors. Nickel-plated steel

| | |
|----------|------------|
| Cat. No. | 239.41.013 |
|----------|------------|

Order qty: Multiples of 10 pcs

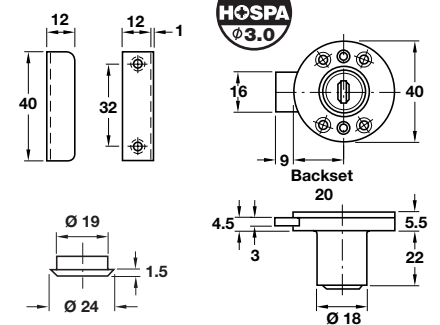
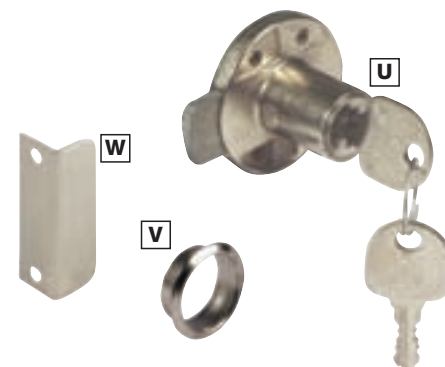

TCH-AI 2008, HUK. Dimensional data not binding. We reserve the right to alter specifications without notice.