

# Fittings for Straight Sliding Timber Cabinet Doors

## Hafele System 1 Infront and System 2 Bottom Rolling

### • Häfele System 1 Infront, top hung

• **Application:** Straight sliding top hung inset cupboard doors, for budget domestic or light-duty commercial furniture

• **Range**

Max. door weight **15 kg**  
Door thickness **16 to 20 mm**

• **System 1 fitting set for 2 doors** comprises fittings **B, C, D, and E**

• Fixing materials are included in the sets

• **Tracks and profiles are not included in the fitting sets and must be ordered separately**

• **For ancillary door hardware i.e. locks, handles and bolts etc. refer to page 19**

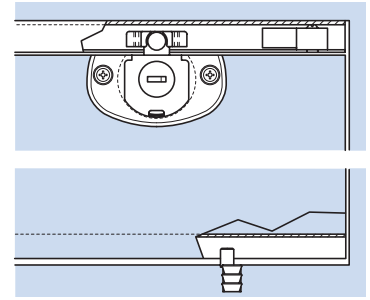
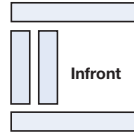

**A Top track**

Pre-drilled for mounting screws. Silver anodised aluminium

Length	2.0 m	3.0 m
Cat. No.	401.21.920	401.21.930

Order qty: 1 pc (2.0 or 3.0 m length)

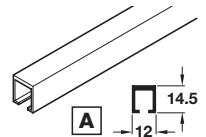
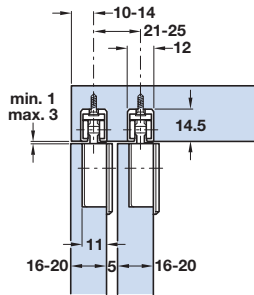

**Häfele System 1 Infront fitting set**

**B Track stopper.** For top track. Black plastic

**C Running gear.** Clip on, for use with housing **D**. Height adjustable  $\pm 2$  mm. Black plastic

**D Housing.** Screw fixing, for use with running gear **C**. Black plastic

**E Bottom guide.** Press-fit. Black plastic

<b>For 2 doors</b>	
<b>B</b> Track stopper	4 pcs
<b>C</b> Running gear	4 pcs
<b>D</b> Housing	4 pcs
<b>E</b> Bottom guide	2 pcs
Cat. No.	401.20.000

Order qty: 1 set (order 1 set per pair of doors)

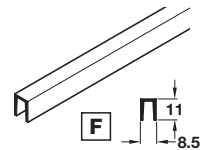
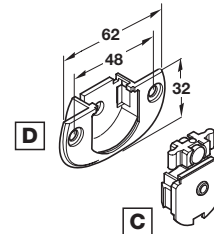
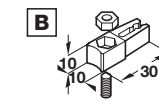

**F Bottom guide profile**

Off-white nylon

Length	Cat. No.
2.0 m	401.22.720

Order qty: 1 pc (2.0 m length)

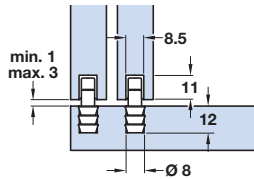
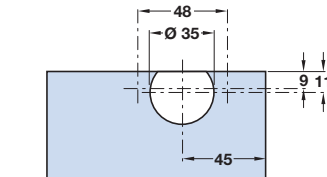

### • Häfele System 2, bottom rolling

• **Application:** Straight sliding bottom rolling inset cupboard doors, for domestic or light-duty commercial furniture, face fixed to rear face of door

• **Range**

Max. door weight **25 kg**  
Door thickness **12 to 18 mm**

• **System 2 fitting set for 1 door** comprises fittings **H, I, and J**

• Fixing materials are included in the sets

• **Tracks are not included in the fitting sets and must be ordered separately**

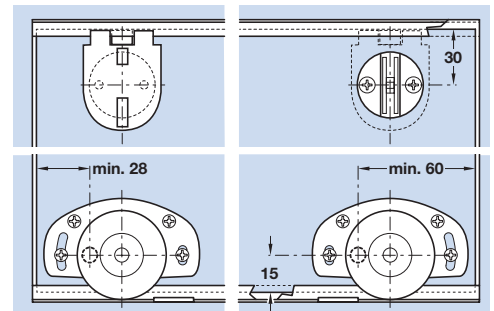
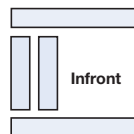

**G Top/bottom track**

Pre-drilled for mounting screws. Surface mounted. Silver anodised aluminium

Length	Cat. No.
2.0 m	401.23.920

Order qty: 1 pc (2.0 m length)

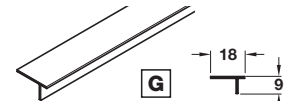
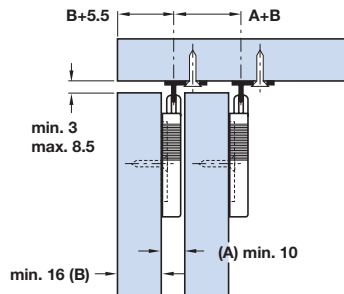

**Häfele System 2 bottom rolling fitting set**

**H Top guide.** Clip on, screw fixing. Black plastic

**I Bottom roller.** Adjustable, screw fixing. Black plastic

**J Bottom track buffer.** Adjustable, screw fixing. Black plastic

<b>For 1 door</b>	
<b>H</b> Top guide	2 pcs
<b>I</b> Bottom roller	2 pcs
<b>J</b> Track buffer	1 pc
Cat. No.	401.20.001

Order qty: 1 set (order 1 set per door)

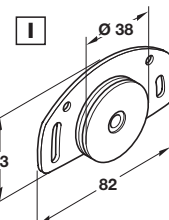
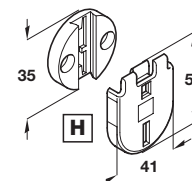

TCH-A1 2008, HUK. Dimensional data not binding. We reserve the right to alter specifications without notice.