

Mod-eez® Modular knock down fittings

- Retaining screws
- Galvanized steel
- Refer to page 54 for Modular plates

Single-sided installation in wood

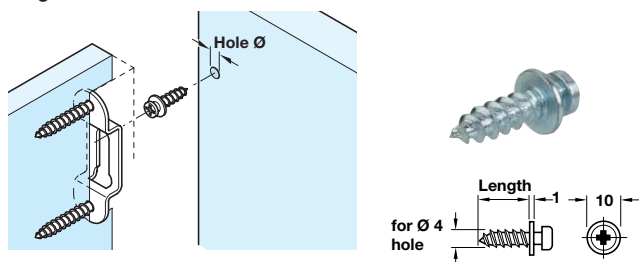

A Modular screw

- Collared
- For use with **11-13 mm** wide Modular plates
- For single sided installation in **wood**
- With woodscrew thread for installation in **Ø 4 mm** hole

Length	Cat. No.
12.5 mm	262.47.978
16.0 mm	262.47.987
25.0 mm	262.47.996
32.0 mm	262.47.870

Order qty: Multiples of 100 pcs

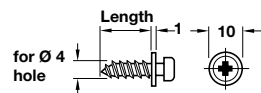

B Modular screw

- Collared
- For use with **16 mm** wide Modular plates
- For single sided installation in **wood**
- With woodscrew thread for installation in **Ø 5 mm** hole

Length	Cat. No.
16.0 mm	262.47.889
32.0 mm	262.47.898

Order qty: Multiples of 100 pcs

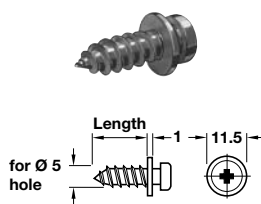

Single-sided installation in wood

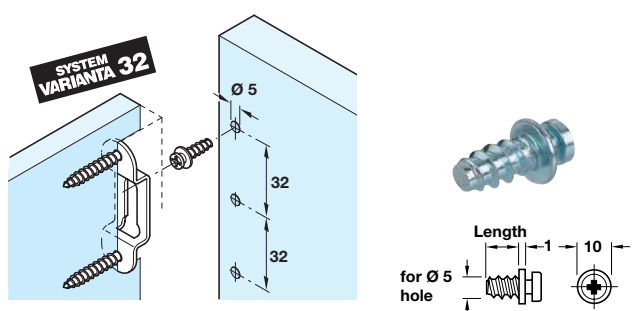

C Modular screw

- Collared
- For use with **11-13 mm** wide Modular plates
- For single sided installation in **wood**
- With special thread for installation in **Ø 5 mm series-drilled holes**

Length	Cat. No.
12.7 mm	262.47.807

Order qty: Multiples of 100 pcs

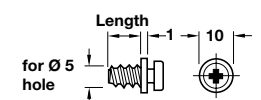

Double-sided installation in wood

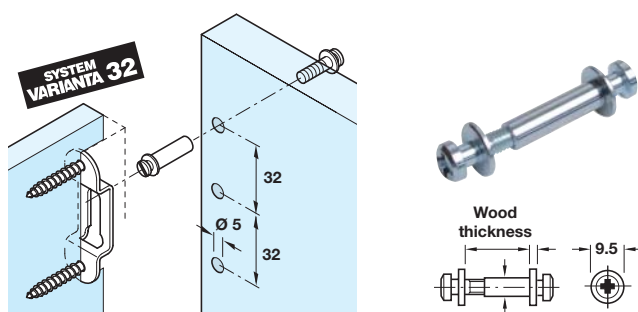

D Modular screw

- Collared
- For use with **10-13 mm** wide Modular plates
- For double sided installation in **wood**
- With M4 thread, for insertion through **Ø 5 mm series-drilled holes**

For wood thickness	Cat. No.
18-21 mm	262.47.952

Order qty: Multiples of 100 pcs

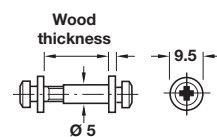

Installation in metal

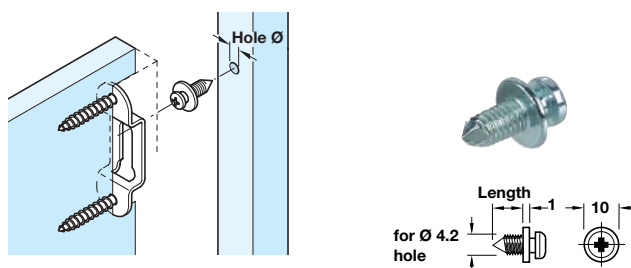

E Modular screw

- Collared
- For use with **10-13 mm** wide Modular plates
- For installation in **metal**
- With self-tapping thread for installation in **Ø 4.2 mm** hole

Length	Cat. No.
9.5 mm	262.47.969

Order qty: Multiples of 100 pcs

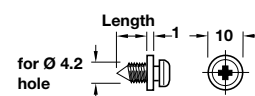

F Modular screw

- Collared
- For use with **16 mm** wide Modular plates
- For installation in **metal**
- With self-tapping thread for installation in **Ø 5.2 mm** hole

Length	Cat. No.
11.0 mm	262.47.861

Order qty: Multiples of 100 pcs

