

- **Screw fixing clip cabinet connector RV** with tolerance compensation
- Fastens panels together by push fitting the two elements together
- Final adjustment with pre-mounted screw, tightened at 9° with a screwdriver - size PZ2 or cross slot

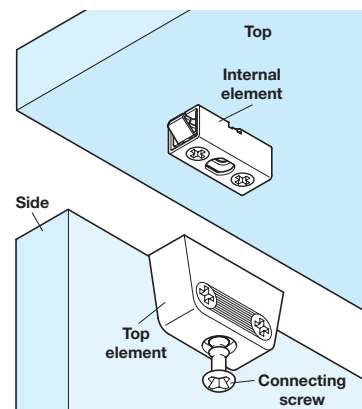
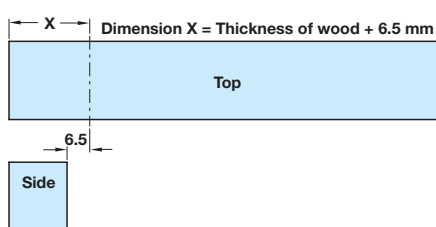
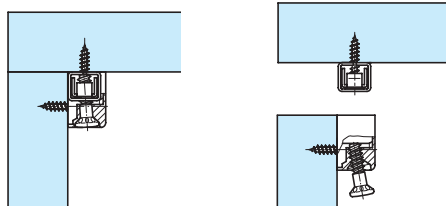

A Clip cabinet connector

- Top element **RV/O** with pre-mounted screw
- Steel connecting screw
- Zinc alloy

Finish	Cat. No.
Chromatized	262.72.901
Nickel-plated	262.72.701
Black	262.72.301

Order qty: Multiples of 100 pcs

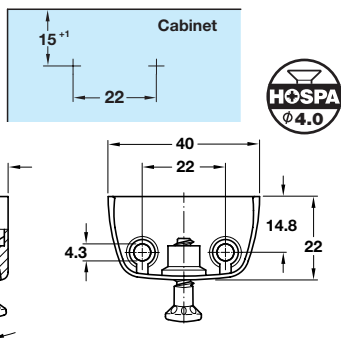

B Clip cabinet connector

- Internal element **RV/U-T3**
- With tolerance compensation ± 1.5 mm
- Steel

Finish	Cat. No.
Galvanized	262.72.953

Order qty: Multiples of 100 pcs

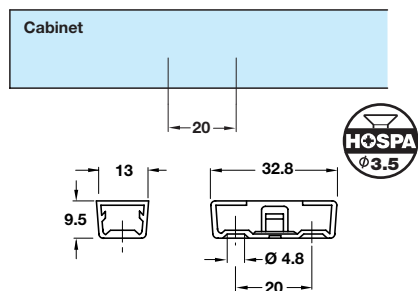

C Mini corner

- With trim cap
- For low loads, for small cabinets
- Plastic

Finish	Cat. No.
White	262.56.708
Beige	262.56.404
Dark brown	262.56.155
Beige (RAL 1001)	262.56.405

Order qty: Multiples of 100 pcs

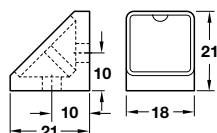
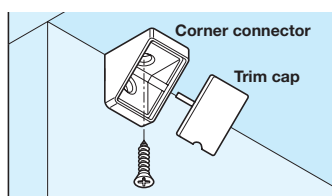

D Mini corner

- With trim cap
- For low loads, for small cabinets
- Plastic

Finish	Cat. No.
White	262.55.710
Beige	262.55.425
Dark brown	262.55.112
Light grey	262.55.550

Order qty: Multiples of 100 pcs

