

A Symo 3000 dead bolt rim lock

- With extended cylinder housing
- For on-site installation of cylinder cores
- Backset: **25 mm**
- Nickel-plated zinc alloy
- Order **lock handle** separately

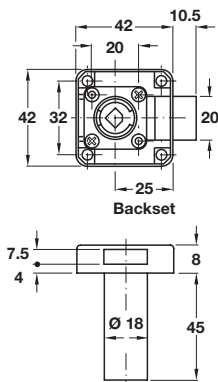

Version	Cat. No.
Left hand	232.26.612
Right hand	232.26.602
Drawer version	232.26.622

Order qty: 1 pc

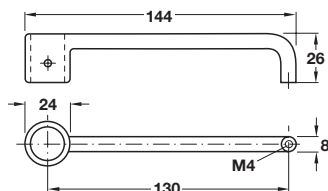

B Symo 3000 lock handle

- For use with rim lock with extended cylinder housing
- For screw fixing (to cylinder housing with SW2 grub screws, handle end to door with M4 screw)
- Zinc alloy

Finish	Cat. No.
Nickel-plated	232.26.699

Order qty: 1 pc

Note: Roller shutter rim lock cores are only suitable for use with **plate lever cylinder cores** shown on page 130

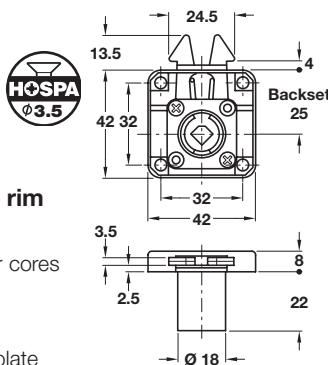
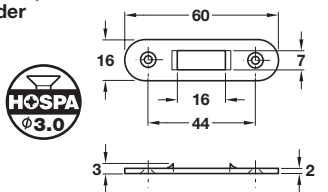

C Symo 3000 roller shutter rim lock case

- For on-site installation of cylinder cores
- Backset: **25 mm**
- Nickel-plated zinc alloy
- **Accessories:** 1x steel striking plate

Version	Cat. No.
Drawer version	232.30.620

Order qty: 1 pc



Illustration and photograph show left hand versions

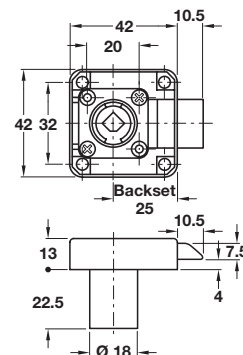

D Symo 3000 spring bolt rim lock case

- For on-site installation of cylinder cores
- Backset: **25 mm**
- The bolt is fixed in the unlocked position
- Nickel-plated zinc alloy
- Order **striking plate E** or **F** separately
- Order **cylinder rosette** separately, shown on page 124

Version	Cat. No.
Left hand	232.37.624
Right hand	232.37.623
Drawer	232.37.625

Order qty: 1 pc

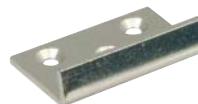
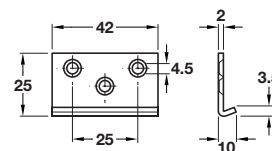
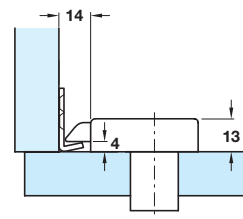

E Angled striking plate

- Steel

Finish	Cat. No.
Nickel-plated	232.37.991

Order qty: 1 pc



F Striking plate

- Steel

Finish	Cat. No.
Nickel-plated	232.37.990

Order qty: 1 pc

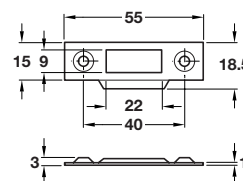

TCH-FF 2010, HUK. Dimensional data not binding. We reserve the right to alter specifications without notice.