

- Please order screws and bolts in multiples of order quantity shown

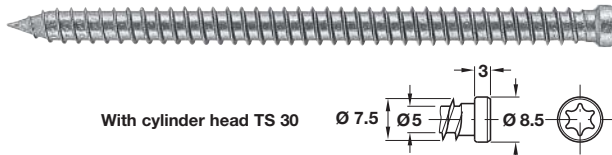

With cylinder head TS 30

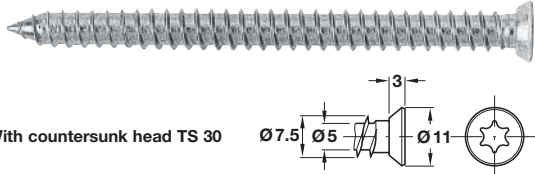

With countersunk head TS 30

Fixing:

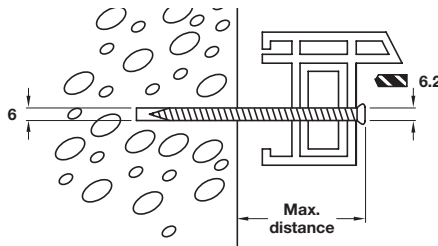
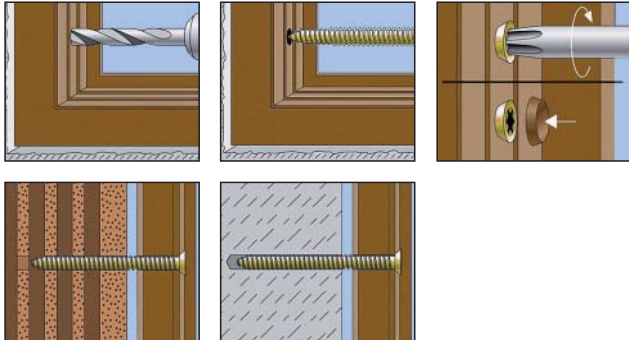

A Window frame screw

- With cylinder head TS30 or countersunk head TS30
- Advantages:
 - Simple, time-saving fitting with permanent and tension free gap
 - High strength combined with a small drill-hole diameter
 - Universal application with all frame materials and types of walls
- Suitable for: Concrete, solid bricks, solid sand-lime bricks, vertically perforated bricks, perforated sand-lime bricks, solid pumice bricks, foam mortar (gas concrete) and stone
- Galvanized steel with low friction coating

Type	Max. distance	Cylinder head	Countersunk head
7.5 x 72	72 mm	051.50.901	051.46.901
7.5 x 92	92 mm	051.50.902	051.46.902
7.5 x 112	112 mm	051.50.903	051.46.903
7.5 x 132	132 mm	051.50.904	051.46.904
7.5 x 182	182 mm	051.50.906	051.46.906

Order qty: Multiples of 100 pcs

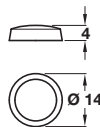

B Cover cap, Ø 14 mm

- For window frame screws with countersunk head
- Plastic

Colour	White	Dark brown
Cat. No.	051.46.090	051.46.091

Order qty: Multiples of 100 pcs

- Screwdriver bits are shown on pages 59-60



Fixing:

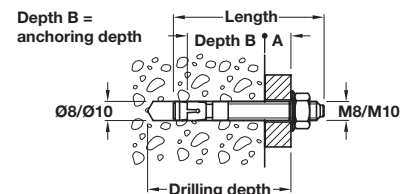
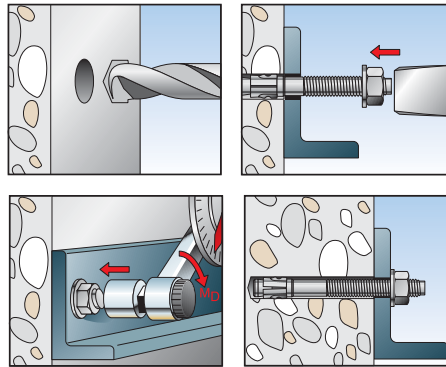

C Fischer FBN anchor bolt for pressure zones

- With M8 or M10 thread
- Drive: 13/17 mm spanner
- Advantages:
 - Even more possibilities with variable fixing thickness and longer thread
 - Optimised expansion clip allows even better holding strength, even in lower quality concrete
 - Firm anchoring with just a few turns
 - Highly economical
- Suitable for: Concrete \geq B15, dense stone
- Galvanized steel

M8 thread, Ø 8 mm drill hole						
FBN Type	Length (mm)	Min. drilling depth	Depth B (mm)	Thickness A (mm)	Cat. No.	Order qty
8/5	58	55 mm	35	5	051.66.006	100 pcs
8/10+23	76	73 mm	48/35	10/23	051.66.007	50 pcs
8/30+43	96	93 mm	48/35	30/43	051.66.008	50 pcs
8/50+63	116	113 mm	48/35	50/63	051.66.009	50 pcs
8/100+113	166	163 mm	48/35	100/113	051.66.010	50 pcs

M10 thread, Ø 10 mm drill hole						
FBN Type	Length (mm)	Min. drilling depth	Depth B (mm)	Thickness A (mm)	Cat. No.	Order qty
10/5	69	65 mm	42	5	051.66.011	50 pcs
10/15+23	89	83 mm	50/42	15/23	051.66.012	50 pcs
10/50+58	124	118 mm	50/42	50/58	051.66.014	20 pcs
10/100+108	174	168 mm	50/42	100/108	051.66.015	20 pcs
10/140+148	214	208 mm	50/42	140/148	051.66.016	20 pcs
10/160+168	234	228 mm	50/42	160/168	051.66.017	20 pcs

TCH-FF 2010, HUK. Dimensional data not binding. We reserve the right to alter specifications without notice.