

# Rafix TAB Housings and Rafix Ø 7 mm Connecting Bolts

**HÄFELE**

Order Online at [www.hafele.co.uk](http://www.hafele.co.uk)

- **Rafix TAB** is an extension of the Rafix range for shelf connections:
- The housing is pressed into the shelf and pushed onto a Rafix Ø 7 mm connecting bolt, selected from the general range
- The tapered surfaces of Rafix TAB ensure an exceptionally tight connection
- Rafix TAB features a catch which prevents the shelf from moving upwards away from the Rafix connecting bolt
- For shelf and support panels, the drop-down shelves can be fastened using Rafix TAB alone
- For tall cabinets, we recommend using Rafix housings, page 119-121



- **A Rafix TAB housings**
- Plastic housing
- For wood thicknesses from 16 mm

Drilling diagram for Rafix TAB

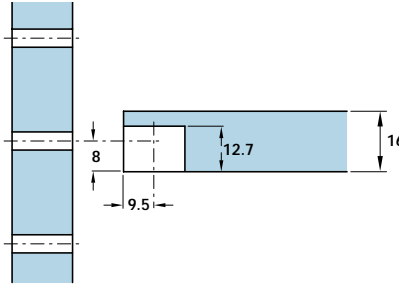

Drilling depth X = depending on housing type and wood thickness (see ordering table)

Dimension A = 1/2 wood thickness (see ordering table)

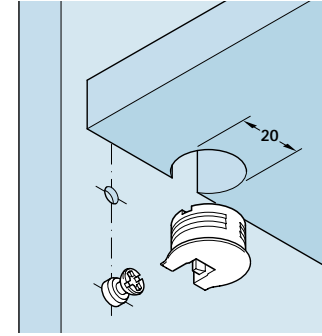

Dimensions in mm

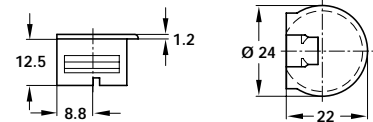

**A** Rafix TAB housings

For wood thicknesses from	Dimension A	Drilling depth X	Cat. No.			
16 mm	8 mm	12.7 <sup>+0.3 mm</sup>	white	beige	brown	black
			263.07.730	263.07.430	263.07.130	263.07.330

Packing: 100 pcs

Drilling diagram for Rafix TAB 'flush'

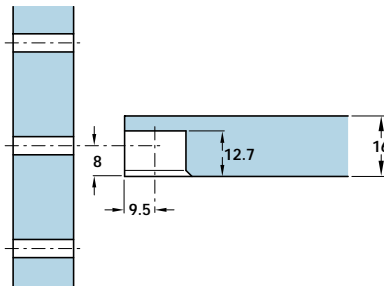

Drilling depth X = depending on housing type and wood thickness (see ordering table)

Dimension A = 1/2 wood thickness (see ordering table)

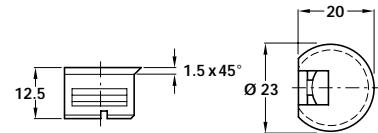
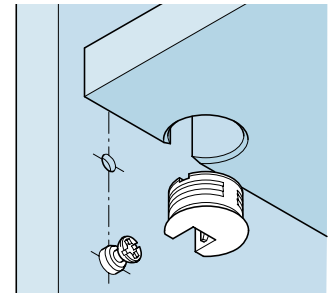

**B** Rafix TAB 'flush' housings

For wood thicknesses from	Dimension A	Drilling depth X	white	beige	brown	black
16 mm	8 mm	12.7 <sup>+0.2 mm</sup>	263.07.730	263.07.430	263.07.130	263.07.330

Packing: 100 pcs

- **Connecting bolts** for insertion through Ø 8 mm holes in side panels
- For single or double-sided constructions



- **C Capped bolts**
- For installation through Ø 8 mm holes
- Steel

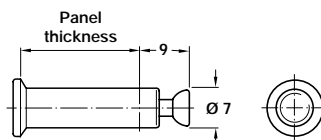

**C** Capped bolts

For side panel thickness	Cat. No.
16 mm	263.25.128
19 mm	263.25.137

Packing: 100 pcs



- **D Double-ended bolts**
- With snap ring for double-sided installation through Ø 8 mm holes
- Steel

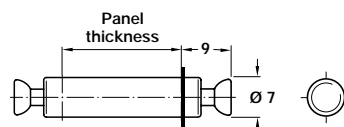

**D** Double-ended bolts

For side panel thickness	Cat. No.
19 mm	263.24.032

Packing: 100 pcs

Order Online at [www.hafele.co.uk](http://www.hafele.co.uk)

- **Rafix TAB** is an extension of the Rafix range for shelf connections:
- The housing is pressed into the shelf and pushed onto a Rafix Ø 7 mm connecting bolt, selected from the general range
- The tapered surfaces of Rafix TAB ensure an exceptionally tight connection
- Rafix TAB features a catch which prevents the shelf from moving upwards away from the Rafix connecting bolt
- For shelf and support panels, the drop-down shelves can be fastened using Rafix TAB alone
- For tall cabinets, we recommend using Rafix housings, page 119-121



- **A Rafix TAB housings**
- Plastic housing
- For wood thicknesses from 16 mm

Drilling diagram for Rafix TAB

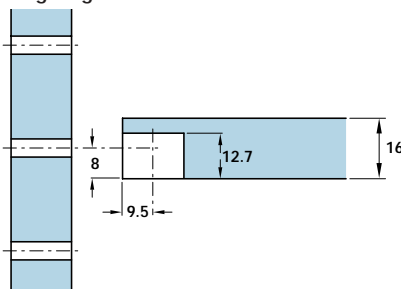

Drilling depth X = depending on housing type and wood thickness (see ordering table)

Dimension A = 1/2 wood thickness (see ordering table)

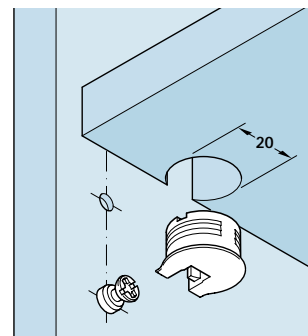

Dimensions in mm

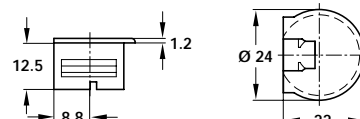

**A** Rafix TAB housings

For wood thicknesses from	Dimension A	Drilling depth X	Cat. No.			
16 mm	8 mm	12.7 <sup>+0.3 mm</sup>	beige			
			263.09.437			

Packing: 100 pcs

Drilling diagram for Rafix TAB 'flush'

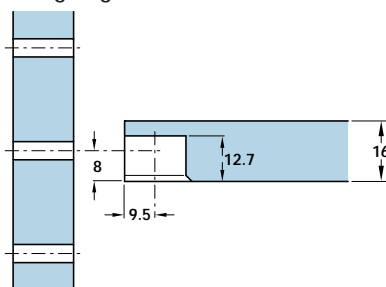

Drilling depth X = depending on housing type and wood thickness (see ordering table)

Dimension A = 1/2 wood thickness (see ordering table)

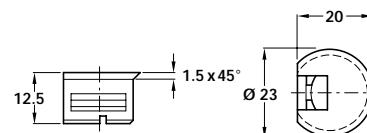
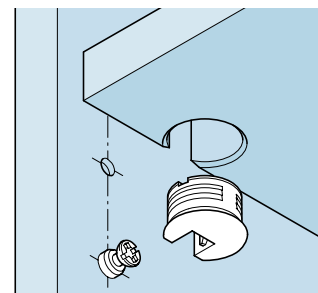

**B** Rafix TAB 'flush' housings

For wood thicknesses from	Dimension A	Drilling depth X	Cat. No.			
			white	beige	brown	black
16 mm	8 mm	12.7 <sup>+0.2 mm</sup>	263.07.730	263.07.430	263.07.130	263.07.330

Packing: 100 pcs

- **Connecting bolts** for insertion through Ø 8 mm holes in side panels
- For single or double-sided constructions



- **C Capped bolts**
- For installation through Ø 8 mm holes
- Steel

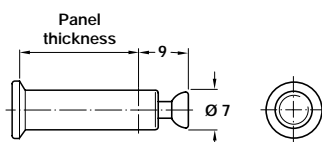

**C** Capped bolts

For side panel thickness	Cat. No.
16 mm	263.25.128
19 mm	263.25.137

Packing: 100 pcs



- **D Double-ended bolts**
- With snap ring for double-sided installation through Ø 8 mm holes
- Steel

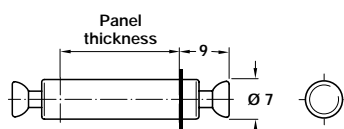

**D** Double-ended bolts

For side panel thickness	Cat. No.
16 mm	263.24.023
19 mm	263.24.032

Packing: 100 pcs